

PHE SM16-100DBSE

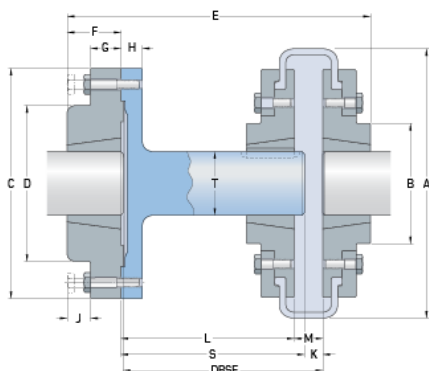

Distance Between Shaft Ends (DBSE) Nominal	100
Distance Between Shaft Ends (DBSE) Max	113
Coupling size	40
Spacer Bush Size	1615
Bore Min (mm)	14
Bore Max (mm)	42
Coupling Bush Size	1008
Bore Min (mm)	9
Bore Max (mm)	25
A	104
B	82
C	127
D	80
E	157
F	38
G	18
H	15
J	14
K	9
L	88
M	22
S	94
T	32

© SKF is a registered trademark of the SKF Group

© SKF Group 2012

The contents of this publication are the copyright of the publisher and may not be reproduced (even extracts) unless prior written permission is granted. Every care has been taken to ensure the accuracy of the information contained in this publication but no liability can be accepted for any loss or damage whether direct, indirect or consequential arising out of the use of the information contained herein.

© SKF is a registered trademark of the SKF Group
© SKF Group 2012

The contents of this publication are the copyright of the publisher and may not be reproduced (even extracts) unless prior written permission is granted. Every care has been taken to ensure the accuracy of the information contained in this publication but no liability can be accepted for any loss or damage whether direct, indirect or consequential arising out of the use of the information contained herein.

